

Silverlink 600 Bains Marie (Dry Heat)

Key Features

- Type: Electric with GN dishes
- Counter-top unit
- Simmerstat temperature control
- Dry heat operation (direct heat)
- Nitrile rubber feet



BM3A

Construction

- Body: stainless steel grade 430
- GN containers and lids: stainless steel grade 304

Available Options

- BM base unit supplied without GN containers and lids
- GN dish configurations

Available Accessories

- Various pedestals and stands

Specifications

Model	BM3	BM4	BM6	BM7
External height (mm)	290	290	290	290
External width (mm)	300	450	600	750
External depth (mm)	611	611	611	611
Container depth (mm)	150	150	150	150
Net weight unpacked (kg)	8.2	10.45	12.5	15.3
Gross weight packed (kg)	14	17	20	23
Shipping volume (m ³)	0.145	0.214	0.255	0.309
Total electrical power rating (kW)	0.5	0.75	0.75	1.0
Electrical supply 1N~+E 230V 50-60Hz Current rating (A)	2.2	3.2	3.2	4.2

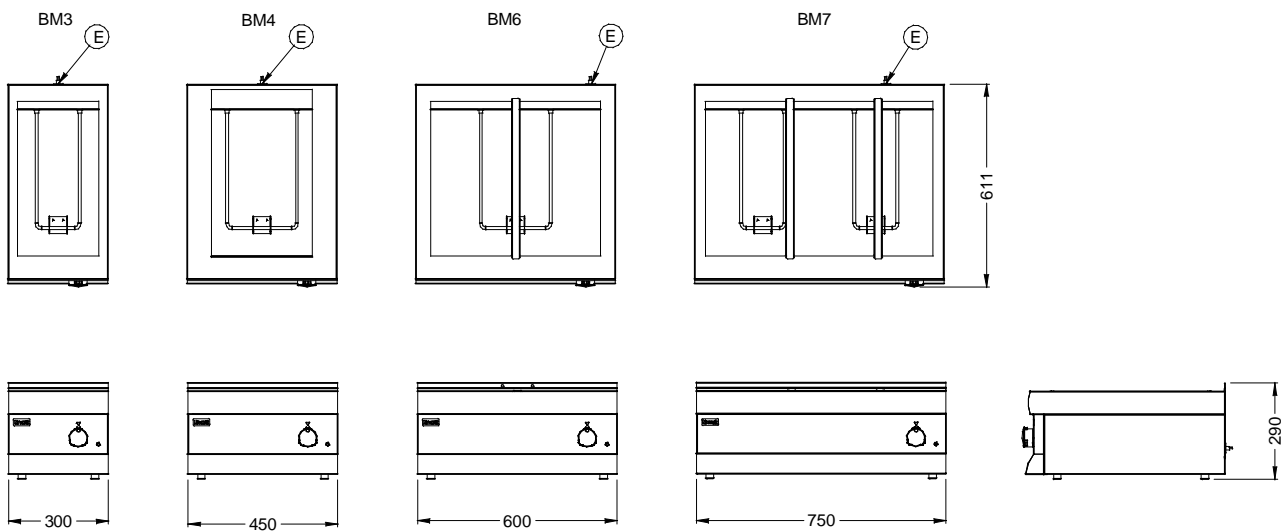

GN Dish Configurations

BM3A

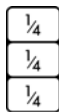

BM4A

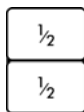

BM4B

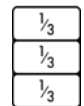

BM4C

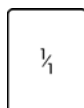

BM6A

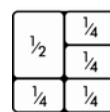

BM6B

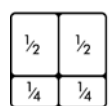

BM6C

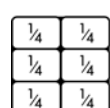

BM7A

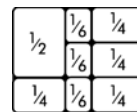

BM7B

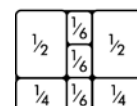

BM7C

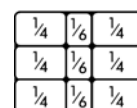

Lincat Limited, Whisby Road,
Lincoln LN6 3QZ,
United Kingdom

UK Sales Tel: 01522 875500 UK Spares Tel: 01522 875510 UK General Tel: 01522 875555
UK Fax: 01522 875530 International Sales Tel: +44 1522 503250 International Fax: +44 1522 875530
Website: www.lincat.co.uk UK Sales e-mail: sales@lincat.co.uk International Sales e-mail: export@lincat.co.uk



Document ref:
S-LINKBAINGAST
Issue date: Oct-09